

INSTRUCTION MANUAL

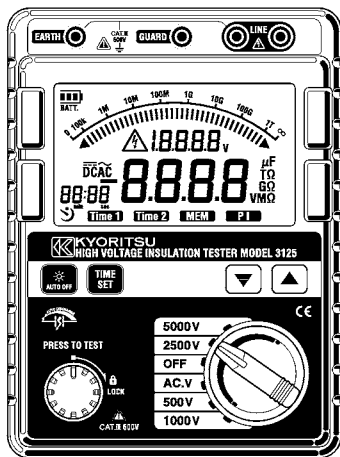

4-range High voltage insulation resistance tester

MODEL 3125



KYORITSU ELECTRICAL INSTRUMENTS
WORKS, LTD.

Contents



1. Safety warnings	1
2. Features	4
3. Specification	5
4. Instrument layout	
4-1 Instrument layout	8
4-2 LCD display	9
5. Preparation for measurement	
5-1 Checking the battery voltage	10
5-2 Connecting test leads	10
6. Measurement	
6-1 Mains disconnection check (Voltage measurement)	11
6-2 Insulation resistance measurement	12
6-3 Continuous measurement	15
6-4 Timer measurement function	16
6-5 Polarization Index measurement	16
6-6 Voltage characteristics of measuring terminal	18
6-7 Use of Guard terminal	19
6-8 Backlight function	20
6-9 Auto-power-off function	20
7. Battery replacement	21
8. Accessories and options	
8-1 Metal part for Line Probe, and replacement	22
8-2 How to use the adaptor for recorder	23
8-3 Line probe with alligator clip	24



1. Safety warnings

This instrument has been designed, manufactured and tested according to IEC 61010: Safety requirements for Electronic Measuring apparatus, and delivered in the best condition after passed the inspection. This instruction manual contains warnings and safety rules which must be observed by the user to ensure safe operation of the instrument and retain it in safe condition. Therefore, read through these operating instructions before using the instrument.

WARNING

- Read through and understand instructions contained in this manual before starting to use the instrument.
- Save and keep the manual at hand to enable quick reference whenever necessary.
- Be sure to use the instrument only in its intended applications.
- Be sure to understand and follow all safety instructions contained in the manual. Be sure to observe the above instructions. Failure to follow the above instructions may cause injury, instrument damage and/or damage to equipment under test.

The symbol  indicated on the instrument means that the user must refer to related parts in the manual for safe operation of the instrument. Be sure to carefully read the instructions following each  symbol in the manual.

- | | |
|---|--|
|  DANGER | is reserved for conditions and actions that are likely to cause serious or fatal injury. |
|  WARNING | is reserved for conditions and actions that can cause serious or fatal injury. |
|  CAUTION | is reserved for conditions and actions that can cause injury or instrument damage. |

DANGER

- Never make measurement on the circuit in which electrical potential to ground over AC/DC600V exists.
- Do not attempt to make measurement in the presence of flammable gasses. Otherwise, the use of the instrument may cause sparking, which can lead to an explosion.
- Never attempt to use the instrument if its surface or your hand is wet.
- Be careful not to short-circuit the power line with the metal part of the test leads when measuring voltage. It may cause personal injury.
- Do not exceed the maximum allowable input of any measuring range.
- Do not press the PRESS TO TEST button with test leads connected to the instrument.
- Never open the battery compartment cover while making measurement.
- Do not touch the circuit under test when measuring insulation resistance or right after a measurement. You may get an electric shock by a test voltage.





WARNING

- Never attempt to make any measurement if any abnormal conditions are noted, such as broken case and exposed metal parts.
- Do not rotate the range switch with the test leads connected to the equipment under test.
- Do not install substitute parts or make any modification to the instrument. Return the instrument to Kyoritsu or your distributor for repair or re-calibration.
- Do not try to replace the batteries if the surface of the instrument is wet.
- Be sure to insert the plug into the terminal firmly when using test leads.
- Make sure to power off the instrument when opening the battery compartment cover for battery replacement.

⚠ CAUTION

- Always make sure to set the range switch to the appropriate position before making measurement.
- Be sure to set the range selector switch to "OFF" position after use and remove test leads. When the instrument will not be in use for a long period, place it in storage after removing the batteries.
- Do not expose the instrument to the direct sun, high temperature and humidity or dewfall.
- Use a cloth dipped in water or neutral detergent for cleaning the instrument. Do not use abrasives or solvents.
- When this instrument is wet, please store it after it dries.

Symbols

	Danger of possible electric shock
	Instrument with double or reinforced insulation
	DC
	AC
	Earth terminal

2. Feature

MODEL3125 is a microcomputer controlled, high voltage insulation resistance tester with 4-range for measuring insulation resistance.

- Designed to following safety standards:
 - IEC 61010-1 (CAT.III 600V Pollution degree 2)
 - IEC 61010-031 (Requirements for hand-held probes)
- With auto-discharge function
When insulation resistance like a capacitive load is measured, electric charges stored in capacitive circuits are automatically discharged after measuring. Discharge can be checked with live voltage graph.
- Backlight function to facilitate working at dimly illuminated location or at nighttime work.
- Bar graph to display measured result
- LIVE circuit warning symbols plus audible warning.
- With Auto-power off function
To prevent the instrument being left powered on and conserve battery power, the instrument automatically turns off approx. 10 min. after the last switch operation.
- With Timer measurement function
Automatically performs a measurement at the set time.
- With Polarization index measurement
The polarization index can be measured by the automatic measurement function of the ratio of resistance in arbitrary two point time.

3. Specification

- Applicable standards

IEC 61010-1	Measurement CAT.III 600V Pollution degree2
IEC 61010-031	Standard for hand-held probes
IEC 61326-1	EMC standard
IEC 60529	IP40

- Measuring range and accuracy

(Temperature, humidity: 23±5C°, 45 ~ 75%RH)

<Insulation resistance tester>

Rated voltage	500V	1000V	2500V	5000V
Measuring Range	0.0 ~ 99.9MΩ 100 ~ 999MΩ	0.0 ~ 99.9MΩ 100 ~ 999MΩ 1.00 ~ 1.99GΩ	0.0 ~ 99.9MΩ 100 ~ 999MΩ 1.00 ~ 9.99GΩ 10.0 ~ 99.9GΩ	0.0 ~ 99.9MΩ 100 ~ 999MΩ 1.00 ~ 9.99GΩ 10.0 ~ 99.9GΩ 100 ~ 1000GΩ
Open circuit Voltage	DC 500V +30%, -0%	DC 1000V +20%, -0%	DC 2500V +20%, -0%	DC 5000V +20%, -0%
Rated Current	1mA or more, 1.2mA or les (at 0.5MΩ load)	1mA or more, 1.2mA or les (at 1MΩ load)	1mA or more, 1.2mA or les (at 2.5MΩ load)	1mA or more, 1.2mA or les (at 5MΩ load)
Short-circuit Current	Approx. 1.3mA			
Accuracy	±5%±3dgt			100GΩ or more, ±20%rdg

Voltage monitor for insulation resistance range

30 ~ 6000V (resolution 10V): ±10%rdg±20V

This monitor is used to check whether electric charge stored on the equipment under test is discharged or not. Measured voltage value displayed on the LCD is a reference value.

Please be noted that the indicated value, when external AC Voltage is applied to the instrument is not the correct value.

<Voltmeter>

	DC voltage	AC voltage
Measuring range	$\pm 30 \sim \pm 600V$	30 ~ 600V(50/60Hz)
Resolution	1V	
Accuracy	$\pm 2\%rdg \pm 3dgt$	

- Operating system: Dual integration
- Display: Liquid crystal display (Max. 999counts)
(1000counts only at 1T Ω is displayed)
AC.V range: Max. 630counts
Bar graph / Max. 36points
- Low battery warning: Battery mark display(in 4 levels)
- Overrange indication: "OL" mark appears on insulation resistance range.
"Hi" mark appears on voltage range.
- Auto-ranging: Range shifts to upper range: 1000counts
Range shifts to lower range: 80counts
(Only on the insulation resistance range)
- Sample rate: approx.0.5 ~ 5 times/sec.
- Auto-power-off: Power off function operates automatically after a switch remains for 10min.
(current consumption: approx.1 μA)
- Operable altitude: 2000m or less above sea level
- Temperature & humidity range(guaranteed accuracy):
23°C \pm 5°C/Relative humidity 85% or less (no condensation)
- Operating temperature & humidity range:
0°C~40°C/Relative humidity 85% or less (no condensation)
- Storage temperature & humidity range:
-20°C~+60°C/Relative humidity 75% or less (no condensation)
- Overload protection: Insulation resistance range: AC1200V/10sec.
Voltage range: AC720V/10sec.
- Withstand voltage: AC5320V(50/60Hz)/5sec.
(Between electrical circuit and enclosure)

- Insulation resistance: 1000M Ω or more/DC1000V
(Between electrical circuit and enclosure)
- Dimension: 205(L) \times 152(W) \times 94(D)mm
- Weight: approx. 1.8kg (battery included)
- Power source: DC12V: Alkaline battery size C(LR14)x 8pcs
- Current consumption: approx.1A(max)

Range	500V	1000V	2500V	5000V	AC.V
Output at short-circuit	220mA				110mA * at voltage measurement
When rated current is outputted	650mA /0.5M Ω	700mA /1M Ω	800mA /2.5M Ω	1000mA /5M Ω	
Output at open circuit	40mA	50mA	80mA	120mA	
On stand-by	25mA				110mA
When backlight is on	Increased by 35mA				

- Measurement time: approx. for 10hours
Representative value till battery voltage of 9.0V
Applying a load of 100M Ω on the Insulation resistance 5000V range.
- Accessories: A set of test leads: MODEL7164

{	Line probe: MODEL7165
	Earth cord: MODEL7166
	Guard cord: MODEL7167

 Alkaline size C battery (LR14) x 8pcs
 Instruction manual
 Hard Case: MODEL9124
 Hook: MODEL8019
- Options: Adaptor for recorder: MODEL8302
 Line probe with alligator clip: MODEL7168

4. Instrument layout

4-1 Instrument layout

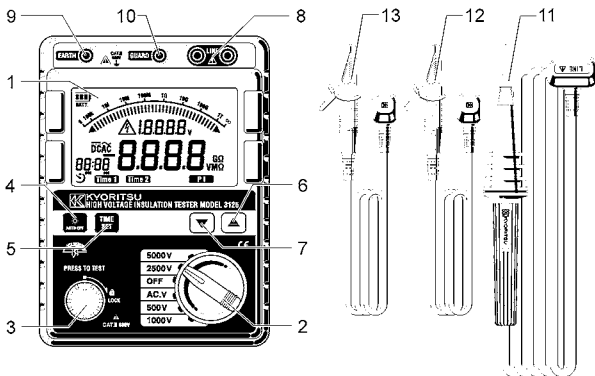

- 1 LCD display
- 2 Range Switch
- 3 PRESS TO TEST button
- 4 Back Light button
- 5 TIME SET button
- 6 Upper button (▲)
- 7 Lower button (▼)
- 8 Line Terminal
- 9 Earth Terminal
- 10 Guard Terminal
- 11 Line Probe (red)
- 12 Earth Cord (black)
- 13 Guard Cord (green)

4-2 LCD display

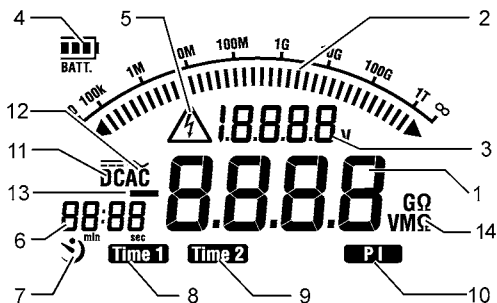

- 1 Insulation resistance
- 2 Bar graph
- 3 Voltage
- 4 Battery mark
- 5 Voltage warning mark
- 6 Timer display
- 7 Timer mark
- 8 TIME1 mark
- 9 TIME2 mark
- 10 PI mark
- 11 DC
- 12 AC
- 13 Minus display
- 14 Unit

5. Preparation for measurement

5-1 Checking the battery voltage

- (1) Set the range switch to any position other than "OFF".
- (2) When the battery mark shown at the upper left on the LCD is last 1 level , the battery is almost exhausted.

Replace the batteries to proceed to measurement.

The instrument operates properly even if under such a low battery, and it may not affect on the accuracy.

When battery mark is vacant , the battery voltage is below the lower limit of the operating voltage. So the accuracy cannot be guaranteed.

Please refer to clause 7. Battery Replacement in which shows how to replace the battery.

5-2 Connecting test leads

Insert the test lead firmly to the connector terminal on the instrument. Connect Line Probe(red) to Line terminal, Earth Cord(black) to Earth terminal and Guard Cord(green) to Guard terminal. To establish guard is not necessary, you do not have to connect Guard cord.

⚠ DANGER

- If "PRESS TO TEST" button is pressed when the range switch is at the insulation measurement position, high voltage may applied on the test lead and you may get an electric shock.

6. Measurement

6-1 Mains disconnection check (Voltage measurement)

⚠ DANGER

- Do not make measurement on a circuit above AC/DC600V (voltage to earth) to avoid possible electric shock. Do not make a measurement, even if the line voltage is 600V or less, when a voltage to earth is over 600V.
- When testing installation that has a large current capacity, such as a power line, be sure to make measurement on the secondary side of a circuit breaker in order to avoid possible hazard to the user.
- Extra precaution shall be taken to minimize the possibility of shorting the power line with the metal tip of test lead at voltage measurement. It may cause personal injury.
- Do not make measurement with the battery cover removed.
- Be sure to connect the Earth Cord (black) to the Earth terminal of the circuit under test.

Voltage can be measured by setting the range switch on this instrument to "AC.V" position. No need to press the "PRESS TO TEST" button. This instrument is equipped with AC/DC auto-detect circuit, and can measure DC voltage. At DC voltage measurement, when applying positive voltage to the Line Probe (red), positive value is displayed on the LCD.

Be sure to turn off the circuit breaker of the circuit under test.

- (1) Connect the Earth Cord (black) to the earth side of the circuit under test and the Line Probe (red) to the line side respectively.
- (2) The voltage displayed on the LCD shall be "Lo". If it is not Lo, voltage is applied on the circuit under test. Check the circuit under test again and the circuit breaker shall be turned off.

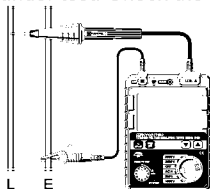

6-2 Insulation resistance measurement

DANGER

- Make sure to check with a high voltage detector that there is no electrical charge exists on the circuit under test.
- Be sure to put on a pair of insulated gloves for high voltage.
- Be extremely careful not to get electric shock during insulation resistance measurement and "PRESS TO TEST" button is being pressed as high voltage is present on the tip of test leads and on the circuit under test continuously.
- Do not make measurement with the battery cover removed.
- Do not make measurement when thunder rumbling.
- Be sure to connect the Earth Cord (black) to the Earth terminal of the circuit under test.

Caution

When the live circuit warning is indicated or the warning buzzer sounds, measurement cannot be made even if "PRESS TO TEST" button is pressed.

To check the insulation of electric equipments or electric circuits, measure their insulation resistance with this instrument.
Be sure to check the voltage which can be applied to the equipment under test before making a measurement.

Note)

- Insulation resistance value of the equipment under test may not be stable, and the indication may be unstable.
- Bleep sound may be heard during insulation resistance measurement. But it is not malfunction.
- It takes time to measure a capacitive load.
- At insulation resistance measurement, positive (+) voltage is outputted from the Earth terminal and negative (-) voltage is outputted from the Line terminal.
Connect the Earth cord to the Earth (ground) terminal.
It is recommended to connect the positive(+) pole to the earth side when measuring insulation resistance against the

ground or when a part of the equipment under test is earthed. With this connection, smaller measured value can be obtained comparing with other way round.

- (1) Check the voltage which can be applied to the circuit under test, and set the range switch to the desired insulation resistance range.
- (2) Connect the Earth cord (black) to the Earth terminal of the circuit under test.
- (3) Put the tip of the Line probe (red) to the circuit under test. Then press the "PRESS TO TEST" button. The buzzer sounds intermittently during measurement when a range other than 500V is selected.
- (4) The measured value will be displayed on the LCD, and it is kept displayed after measurement.

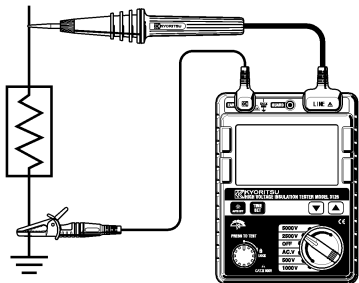

⚠ Caution
Always turn off the breaker for the circuit under test.

This instrument has an auto-discharge function.

With the test leads connected to the circuit under test, release the "PRESS TO TEST" button to discharge capacitance in the circuit after test.

Check that the indication on the voltage monitor is "0V".

⚠ DANGER

- Do not touch the circuit under test immediately after testing. Capacitance stored in the circuit may cause electric shock.
- Leave test leads connected to the circuit and never touch the circuit until the discharge is complete.

Auto-discharge function

This is a function to release capacitance stored in the circuit under test automatically after testing. Discharge condition can be checked with a live voltage graph. This function will be released by removing test leads 2sec. or more before discharge is complete.

- (6) Set the range switch to "OFF" position, and remove test leads from the instrument.

Note)

Current of about 25mA(at auto-power off: about 1 μ A) is consumed when the range switch is at any range other than "OFF" position. Be sure to turn the range switch to "OFF" position when not using the instrument. Refer to clause 6-9 in this manual for about Auto-power-off function.

Principle of Insulation Resistance Measurement

Resistance value can be obtained by applying a certain high voltage to the resistance (insulation resistance) and measuring the flowing current.

Resistance value = Voltage / Current

$$(RX = V / I)$$

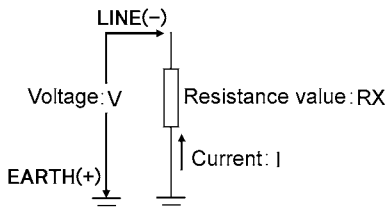

6-3 Continuous Measurement

Pressing and turning the “PRESS TO TEST” button clockwise to perform a continuous measurement of insulation resistance. Then the button is locked, and continuous measurement can be performed. After testing, turn the button to counterclockwise and set it to the initial position.

⚠ DANGER

- Be extremely careful not to get electric shock as high voltage is present on the tip of test leads continuously.

6-4 Timer measurement function

This is a function to conduct a test automatically at any set time.

- (1) Press the TIME SET button on the insulation resistance range, then make the instrument to timer measurement mode. TIME1 mark is displayed at the bottom part of the LCD.
- (2) Time is set by upper and lower button (▲ and ▼).
Initial set value: 01:00
Settable range: 00: 05 ~ 59:30
Time can be set at every 5sec. up to 1min.
From 1 min. or later, time can be set at every 30sec..
To lengthen the time, press the upper button, and to shorten the time, press the lower button.
- (3) Press the PRESS TO TEST button while TIME1 mark is being displayed.
- (4) Measurement is automatically ended at the set time. And the insulation resistance value will be displayed on the LCD.

Note) Under the timer measurement function, PRESS TO TEST button shall be kept pressed until the set time comes. So it is convenient to use continuous measurement function. When the button is released before the set time comes, measured value at that moment is displayed. When the button is pressed again, measurement can be re-started.

6-5 Polarization Index measurement (can be set to any time)

The polarization index can be measured by the automatic measurement function of the ratio of resistance in arbitrary two point time.

- (1) Press the TIME SET button on the insulation resistance range. Then TIME1 mark will be displayed on the LCD. Time is set by upper and lower button (▲ and ▼). Set TIME1 first.
Initial set value: 01:00
Settable range: 00: 05 ~ 59:30
Time can be set at every 5sec. up to 1min.
From 1 min. or later, time can be set at every 30sec..

To lengthen the time, press the upper button, and to shorten the time, press the lower button.

- (2) After setting TIME1, press the TIME SET button again to set TIME2. When pressing the TIME SET button, TIME2 mark will be displayed on the LCD. Time is set by upper and lower button (▲ and ▼).

Initial set value: 10:00

Settable range: 00:10 ~ 60:00

Time can be set at every 5sec. up to 1min. .

From 1 min. or later, time can be set at every 30sec..

To lengthen the time, press the upper button, and to shorten the time, press the lower button.

- (3) Press the PRESS TO TEST button while TIME2 mark is being displayed.
- (4) Measurement is ended at the set time at TIME2, and the ratio; insulation resistance at TIME2 ÷ insulation resistance at TIME1, is automatically displayed on the LCD. Indication of “insulation resistance at TIME2” and “insulation resistance at TIME1” can be switched by pressing upper or lower button.

Polarization Index measurement can be conducted when TIME1 is set to 1 min. and TIME2 is set to 10 min

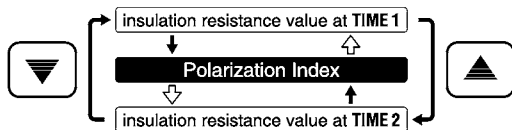

Polarization index measurement

Polarization index is one of the factors to check the condition of insulation. The polarization index is defined as the ratio between the resistance value measured after 10min. and the resistance value measured after 1min. from the beginning of measurement.

$$\text{Polarization index} = \frac{\text{resistance value measured after 10min (TIME2)}}{\text{resistance value measured after 1min (TIME1)}}$$

Settable range is as follows.

TIME1 00:05~59:30 TIME2 00:10~60:00

Polarization index varies with moisture absorption regardless of the shape or size of insulator.

Therefore, it gives significant criteria to verify the insulation.

(Refer to following table.)

Polarization index	4 or more	4.0 ~ 1.5	1.5 ~ 1.0	1.0 or less
Criteria	very good	good	dubious	unsatisfactory

6-6 Voltage characteristics of measuring terminal

MODEL3125 Output characteristics

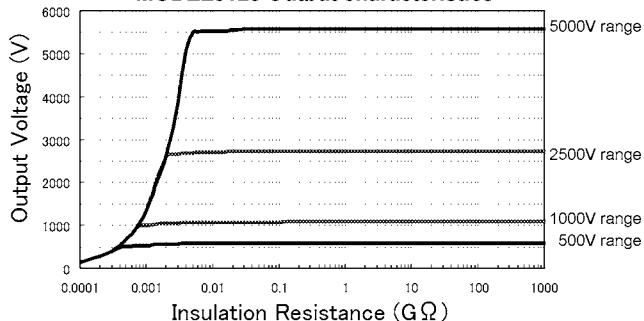

6-7 Use of Guard terminal

When measuring the insulation resistance of a cable, leakage current flowing on the surface of cable jacket and the current flowing inside the insulator are mixed and may cause error in insulation resistance value. In order to prevent such error, wind a conductive wire around the point where leakage current flows. Then connect it to the Guard terminal as shown in below figure. This is to move out the surface leakage resistance of the cable insulation to measure only the volume resistance of insulator. Make sure to use the Guard cord supplied with this instrument to connect the instrument to Guard terminal.

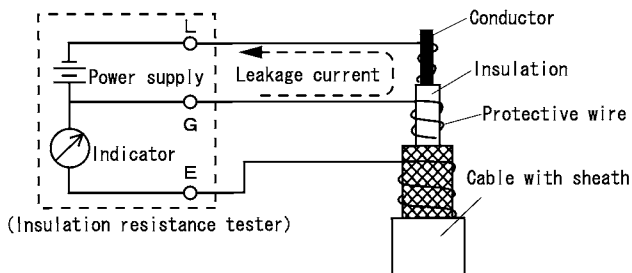

6-8 Backlight function

This function to facilitate working at dimly illuminated location or at nighttime work.

Press the backlight button when the range switch is at any position other than "OFF". The backlight will light up for about 40 sec., and then turned off automatically.

6-9 Auto-power-off function

The instrument automatically turns off approx. 10 min. after the last switch operation. When timer measurement is conducted, the instrument automatically turns off approx. 10 min. after measurement. To return to the normal mode, turn the range switch off, then to the desired position.

7. Battery replacement

⚠ DANGER

- Never open the battery compartment cover while making measurement.

⚠ WARNING

- To avoid possible electric shock, remove test leads before opening the battery compartment cover. After replacing batteries, be sure to tighten up the screw for battery compartment cover.

⚠ CAUTION

- Do not mix new and old batteries.
- Make sure to install batteries in correct polarity as marked inside.

- (1) Set the range switch to "OFF" position, and remove the test leads from the instrument.
- (2) Loosen the battery compartment cover fixing screws, and remove the battery compartment cover. Always replace all 8 batteries with new one at the same time.
- (3) After replacing batteries, be sure to tighten up the screw for battery compartment cover.

Make sure to install batteries in correct polarity as marked inside.

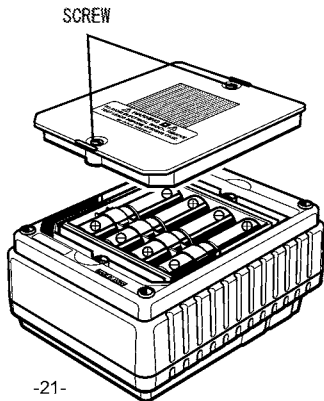

8. Accessories and options

8-1 Metal part for Line Probe, and replacement

(1) Tip metal parts

MODEL8303: Prod

To be used for general measurement.

Been attached to the Line probe.

MODEL8019: Pickel Type Prod (accessory)

To be used to hook the instrument.

(2) How to replace it

Turn the Line probe counterclockwise to remove the attached tip metal. Put the tip metal you want to use to the hexagon socket and turn it to clockwise together with the tip of probe, and tight up screws.

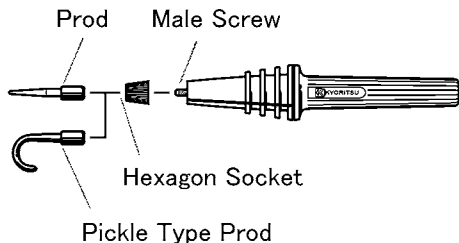

8-2 How to use the adaptor for recorder

MODEL8302 is the adaptor for recorder (option) for output current measurement. Connect it as shown in the below figure. Output is DC1mV when current of 1 μ A is flowing.

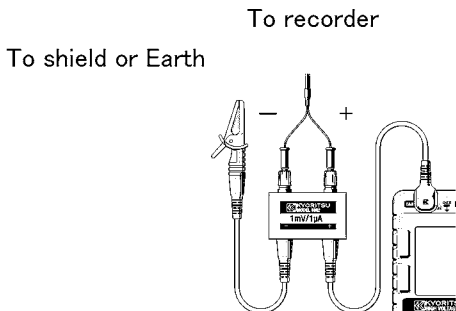

8-3 Line probe with alligator clip

MODEL7168 Line probe with alligator clip
(option)

