

SCALE OPTIONS: 131002.200 NLF
131002.200 NM
MICROSCALE: 131005.2NM

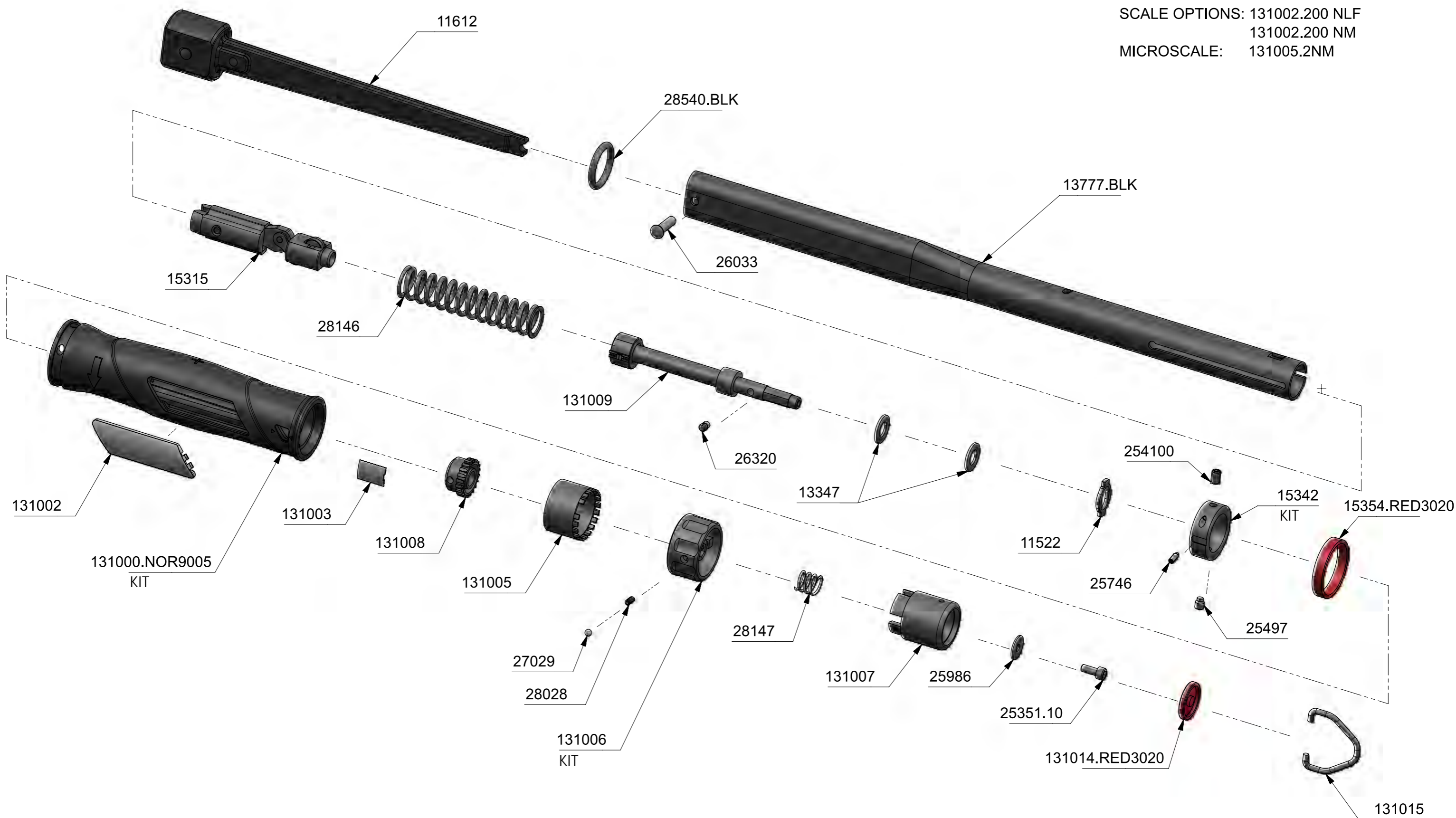

130126 - NORTORQUE MDL 200 14x18 FEMALE END N.m/lbf.ft

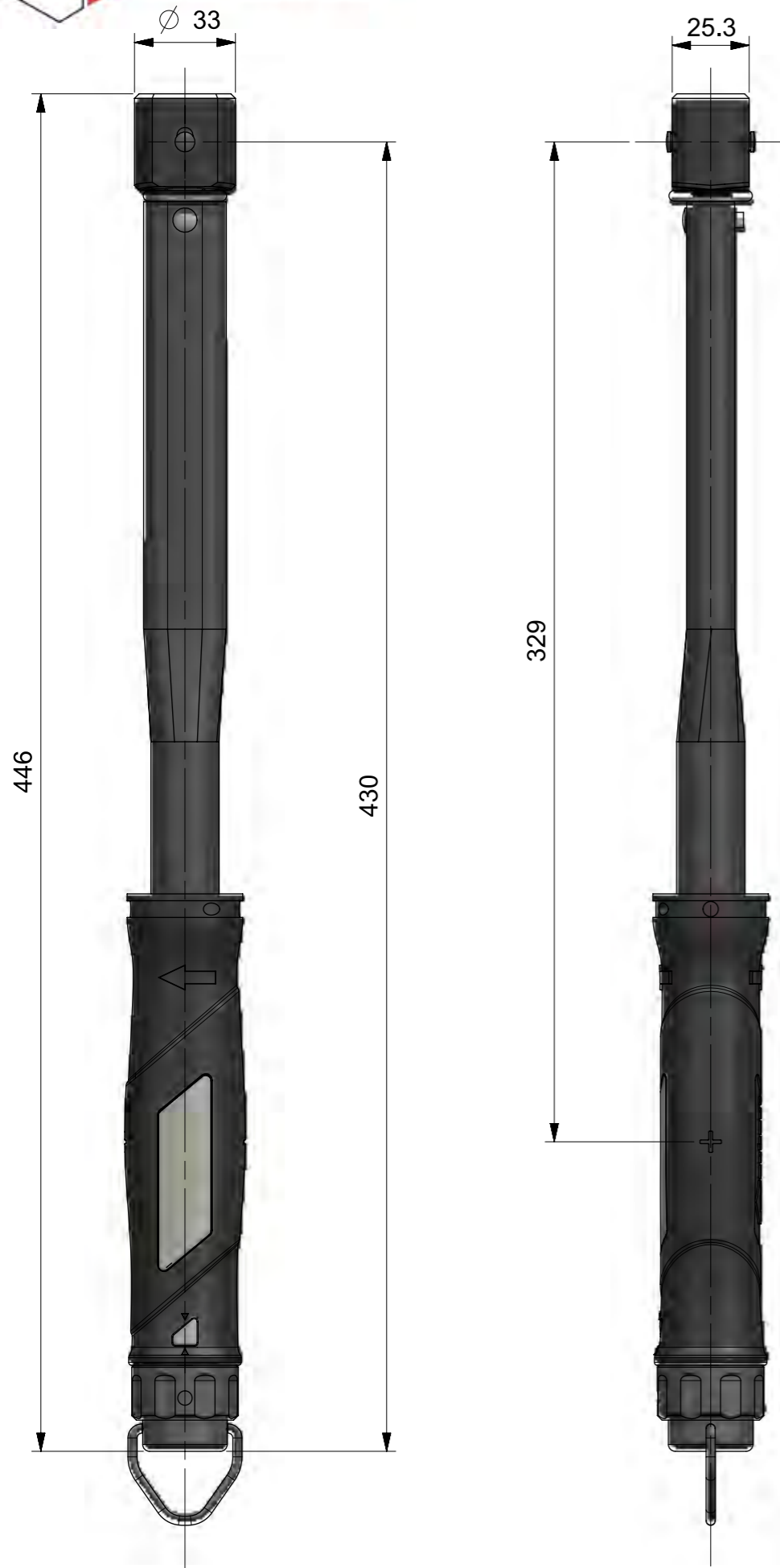

13777.BLK	1	NORTORQUE MODEL 200 BODY TUBE - BLACK METALLIC
26033	1	PIVOT PIN TES 3487
28540.BLK	1	O RING 15.47 ID 3.53 SECT BLACK
15315	1	SECONDARY MOTION ASSEMBLY
28146	1	MAIN COMPRESSION SPRING NORTORQUE
131009	1	NORTORQUE/SLIMLINE ADJUSTING SCREW ASSEMBLY - MDL 60, 100, 200
13347	2	TT HARDENED WASHER
11522	1	END STOP
15342	1	THRUST WASHER SIDE LOCKING
15354.RED3020	1	NORTORQUE CALIBRATION HOLE COVER BAND RED RAL3020
131002	1	MAIN SCALE LENS
131008	1	STATIONARY GEAR
131003	1	NORTORQUE MICRO SCALE LENS
131005	1	MICRO GEAR
28028	1	SPRG/COMP 3DIAx6.35x0.5WD
27029	1	3.8 MM STEEL BALL
131007	1	PUSH PULL LOCKING KNOB
131006	1	ADJUSTING KNOB
28147	1	NORTORQUE CLEARANCE REMOVAL SPRING
25986	1	WASHER M4X14X0.8 TYPE L ZINC PLATED
25351.10	1	SHCS M4 x 10 - 12.9 TO ISO 4762
131014.RED3020	1	NORTORQUE/SLIMLINE TW LOCKING KNOB END BUNG - RED RAL 3020
131015	1	NORTORQUE/SLIMLINE ADJUSTING KNOB HANGER
254100	1	SCR SKT GRUB M5 x 8 LONG OVAL
25746	1	M3 DOG POINT GRUB SCREW T6 TORX DRIVEN
25497	1	SSS M5X5LG DOG POINT -12.9 TO ISO4028
26320	1	PIN HALF GROOVED 4MM DIA X 6 LG MILD STEEL
131000.NOR9005	1	NORTORQUE HANDLE - NORBAR BLACK RAL9005
11612	1	LVR ARM 200 FEMALE T/H 14mm x 18mm
Part No	Qty	Description